

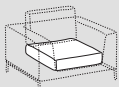

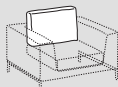



# Hall

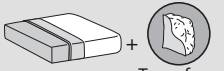

	 Seduta - Seat	 Schienale - Backrest	-	Mix - Mix
<b>Rivestimento Upholstering (7)</b>	Sfoderabile Removable	-	-	-
	Non sfoderabile Not removable			 / 
<b>Imbottiture Padding (3-4-5-6)</b>	 D.40kg/m <sup>3</sup>	 D.25/30kg/m <sup>3</sup>	-	-

## INFORMAZIONI TECNICHE

### Struttura: 1

Masselli portanti in legno di abete. Elementi strutturali in pannelli di legno multistrati in classe E1, tamponamenti in faesite.

### Molleggio: 1-2

Schienale in pannello di faesite. Seduta in nastri elastici di fibra propilenica e lattice incrociati e meccanicamente pretensionati.

## TECHNICAL INFORMATION

### Structure: 1

Solid fir wood. Structural elements in multilayer wood panels in class E1, infills in faesite.

### Springing: 1-2

The back is made of hardboard panels. Seat with pre-tensioned crossed propylene fibre and latex elastic webbing.

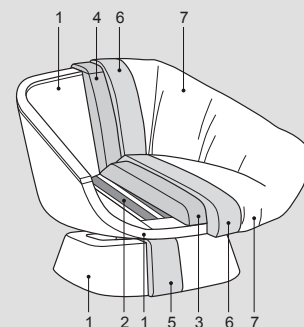
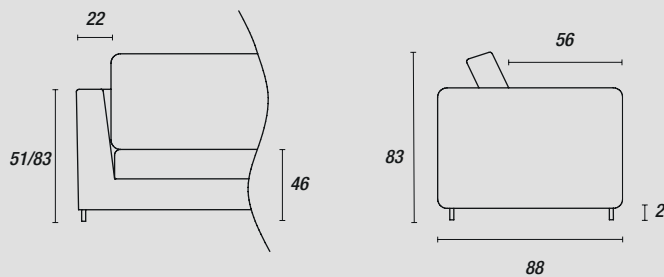

Piedini - Feet::

